

ISL78171EVAL1Z Evaluation Board User Guide

Description

This quick start guide pertains to the ISL78171EVAL1Z Evaluation Board. This board is populated with 60 LEDs in 6P10S (six parallel strings, each string consisting of 10 LEDs in series) configuration to simplify evaluation and testing. The device can function with or without an I²C controller. If it is required to use I²C control for the ISL78171EVAL1Z board, use a generic I²C interface adapter (not supplied with the evaluation board kit) for the purpose of communication. Please note that the slave address on the [ISL78171](#) is hexadecimal 58. Please refer to the quick setup guides for jumper settings and power-up instructions.

Specifications

This board has been configured and optimized for the following operating conditions:

- Input voltage: 4.5V to 26.5V
- Output voltage: 32V typical and 40V max
- LED string current 20mA typical

PCB Details

Board dimension = 5.525x2.550inch

Number of layers = 2

Type = FR4

Copper thickness = 2oz

Key Features

- Integrated 40V boost converter
- 6 Precision current sinks, up to 50mA each
- Current matching $\pm 0.7\%$ typical
- Dimming modes: DC, internal PWM, direct PWM, DC + Int/Dir PWM
- Typical dimming ratio exceeding 60,000:1 for DC + Int/Dir PWM
- Phase shift control for internal PWM dimming
- 600kHz/800kHz/1.2MHz I²C selectable switching frequency
- Dynamic headroom control

References

[ISL78171](#) Datasheet

Ordering Information

PART NUMBER	DESCRIPTION
ISL78171EVAL1Z	ISL78171 Evaluation Board

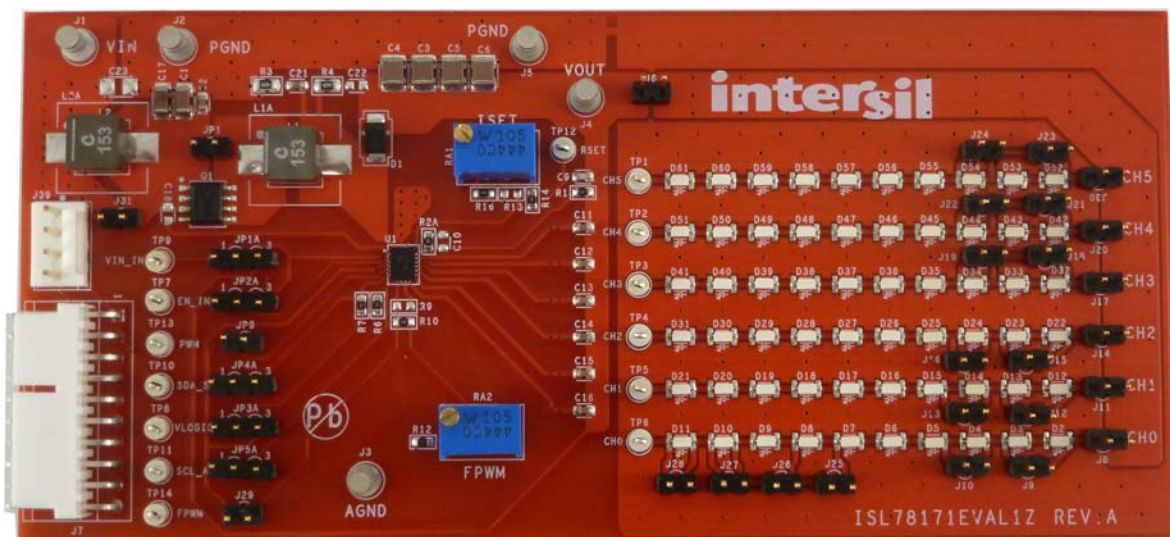

FIGURE 1. ISL78171EVAL1Z FRONT SIDE

Recommended Equipment

The following equipment is recommended to perform testing:

- 0V to 30V power supply with 5A source current capability
- Digital Multimeters (DMMs)
- 500MHz quad-trace oscilloscope
- Signal generator for PWM pins

Quick Setup Guide (Non I²C)

1. Ensure that the circuit is correctly connected to the supply.
2. Connect the VIN+ supply to both J1 = BOOST-VIN and TP9 = VIN_IN.
3. OPEN: Jumpers JP1, JP9, J9, J10, J12, J13, J15, J16, J18, J19, J21, J22, J24, J25, J26, J27 and J28.
4. CLOSE: Jumpers JP1A:1-2, JP2A:2-3, JP3A:2-3, JP4A:2-3, JP5A:2-3, J6, J8, J11, J14, J17, J20, J29, J30 and J31.
5. Apply 200Hz, 0-5V, 50% duty, square wave to TP13.
6. Measure the voltage between J4 and J5. IT should read ~32V
7. Note that the 6P10S LED strings are ON.
8. Apply 5V to TP13 and trim RA1 to set the LED current in CH0 to measure 20mA using a DMM in series with J8.
9. Apply a square wave of 200Hz, 5V and vary the duty from 0% to 100% and check that the LED varies from OFF to 100% brightness.
10. Check that the current in J8 in step 9 varies from ~0mA to 20mA. Test complete turn OFF supplies.

Quick Setup Guide (I²C)

1. Ensure that the circuit is correctly connected to the supply.
2. Connect the VIN+ supply to both J1 = BOOST-VIN and TP9 = VIN_IN.
3. OPEN: Jumpers JP1, JP9, J9, J10, J12, J13, J15, J16, J18, J19, J21, J22, J24, J25, J26, J27, J28 and J29.
4. CLOSE: Jumper JP1A:1-2, JP2A:2-3, JP3A:2-3, JP4A:1-2, JP5A:1-2, J6, J8, J11, J14, J17, J20, J30 and J31.
5. Connect an I²C controller bus to either J7 or J39.
6. Set device address to 0x58.
7. IC enable is shorted to VIN by connecting jumper JP2A:2-3, so that the EN is driven by TP9.
8. VLOGIC level for I²C can be generated from VDC by connecting jumper JP3A:2-3. VLOGIC can be driven from TP7 (VLOGIC) by shorting jumper JP3A:1-2.
9. The configuration of VIN (JP1A), EN (JP2A) and VLOGIC (JP3A) can be quickly found by referring to the table printed on the bottom of the evaluation board, as shown in [Figure 6 on page 7](#).
10. There are 4 different operation modes for ISL78171. The setting for each mode is shown on the other table printed on the bottom of the evaluation board, as shown in [Figure 6 on page 7](#).
11. For I²C/SMBUS and DPST mode, connect the I²C interface board to the ISL78171EVAL1Z board.

12. For I²C/SMBUS and DPST mode, in order to enable the board, write a hex 58 for slave address and write a hex 05 to register 01.
13. For DPST mode I²C dimming, write hex 01 to register 01 (see data sheet for more details).
14. For DPST mode with PWM dimming, write hex 03 to register 01. This will allow PWM dimming in DPST mode.

TABLE 1. LED STRINGS CONFIGURATIONS WITH DIFFERENT JUMPER SETTINGS

LED CONFIGURATION	6P10S	6P9S	6P8S
J6	Short		
J8	Short		
J11			
J14			
J17			
J20			
J30			
J10	Open	Short	Open
J13			
J16			
J19			
J22			
J24			
J9	Open	Open	Short
J12			
J15			
J18			
J21			
J23			

15. The LED current can be programmed by varying POT RA1 using [Equation 1](#):

$$I_{LED} = 410.5 / (R_{A1} + R_{16}) = 410.5 / R_{13} \quad (\text{EQ. 1})$$

The measured current divided by six is the LED current per channel. For example, 120mA measured current will correspond to 20mA/channel.

16. The PWM dimming frequency can be adjusted by varying pot RA2 using [Equation 2](#):

$$F_{PWM} = 6.66 \times 10^7 / (R_{A2} + R_{12}) \quad (\text{EQ. 2})$$

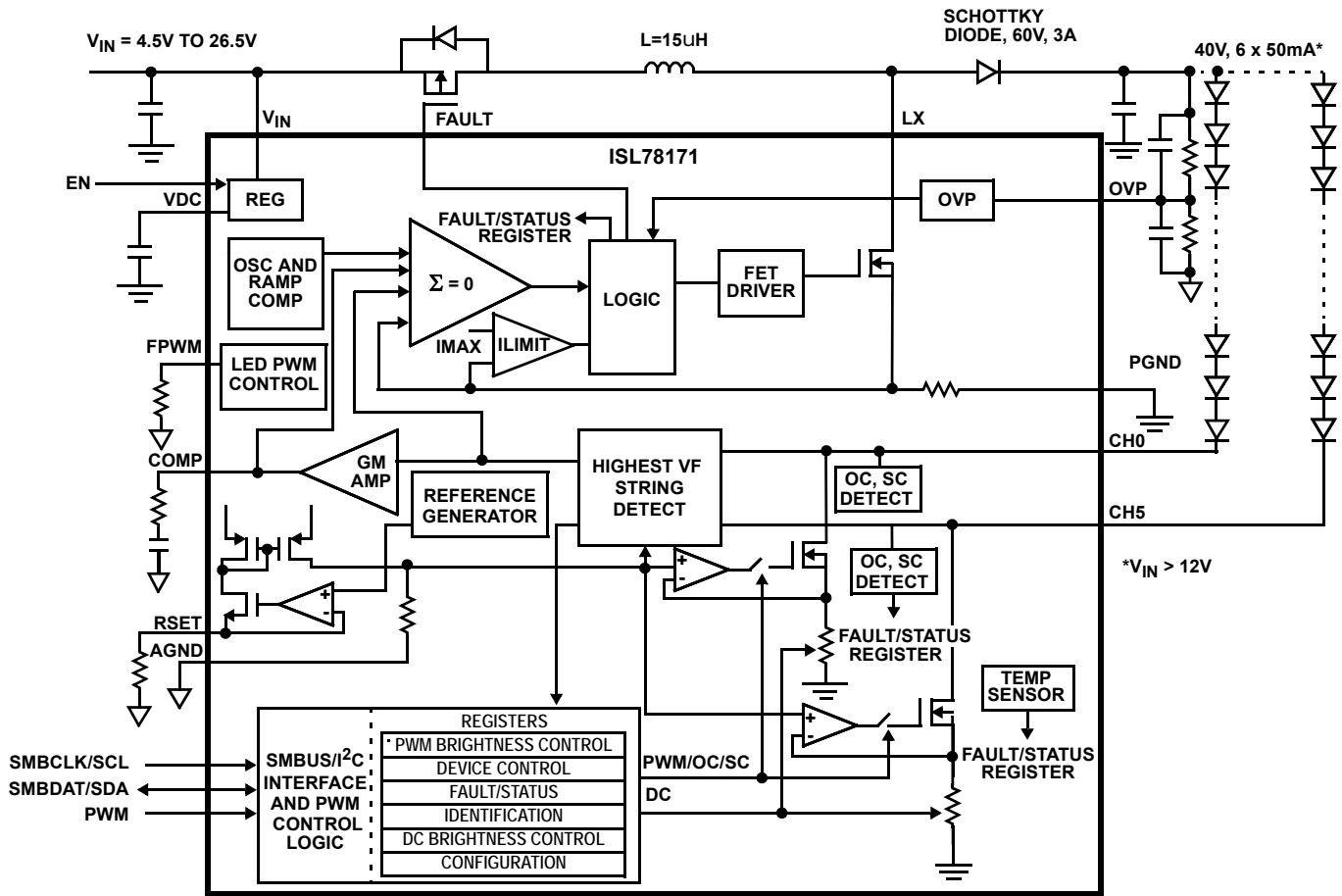

FIGURE 2. ISL78171 BLOCK DIAGRAM

PCB Layout Recommendation

The PCB layout is very important for normal functioning of the ISL78171, to ensure the system works with low EMI. The main power loop is composed of the input capacitor, boost inductor, the output capacitor, the LX pin and the PGND pin. It is necessary to make the power loop as small as possible and the connecting traces among them should be direct, short and wide. The switching node of the boost converter (LX pins) and the traces connected to the node are noisy, so keep the low level signals away from these noisy traces. The input capacitor should be placed as close as possible to the VIN and GND pins. The ground of input and output capacitors should be connected as close as possible. The heat of the IC is mainly dissipated through the thermal pad. Maximizing the copper area connected to the thermal pad is preferable. In addition, a solid ground plane is helpful for better EMI performance. It is recommended to add at least 6 vias ground connection within the pad for the best thermal conduction. Keep the PGND plane and AGND plane separate and connect them at the thermal pad.

EMI Considerations

The LX node switches at the VIN potential so its capacitance to GND should be made minimized. This is achieved by keeping the LX copper island as small as possible and by opening the copper GND area directly below it. This prevents injection of the switching frequency noise directly into the GND, and reduces the conducted EMI for the system. The evaluation board also has an input LC filter option on it i.e., L2/L2A and C23. These components are not populated on the PCB but can be soldered in for the purpose of EMI evaluation if needed. The snubber R3 and C21 helps to reduce the peak voltage seen on the LX pin.

ISL78171EVAL1Z Layout

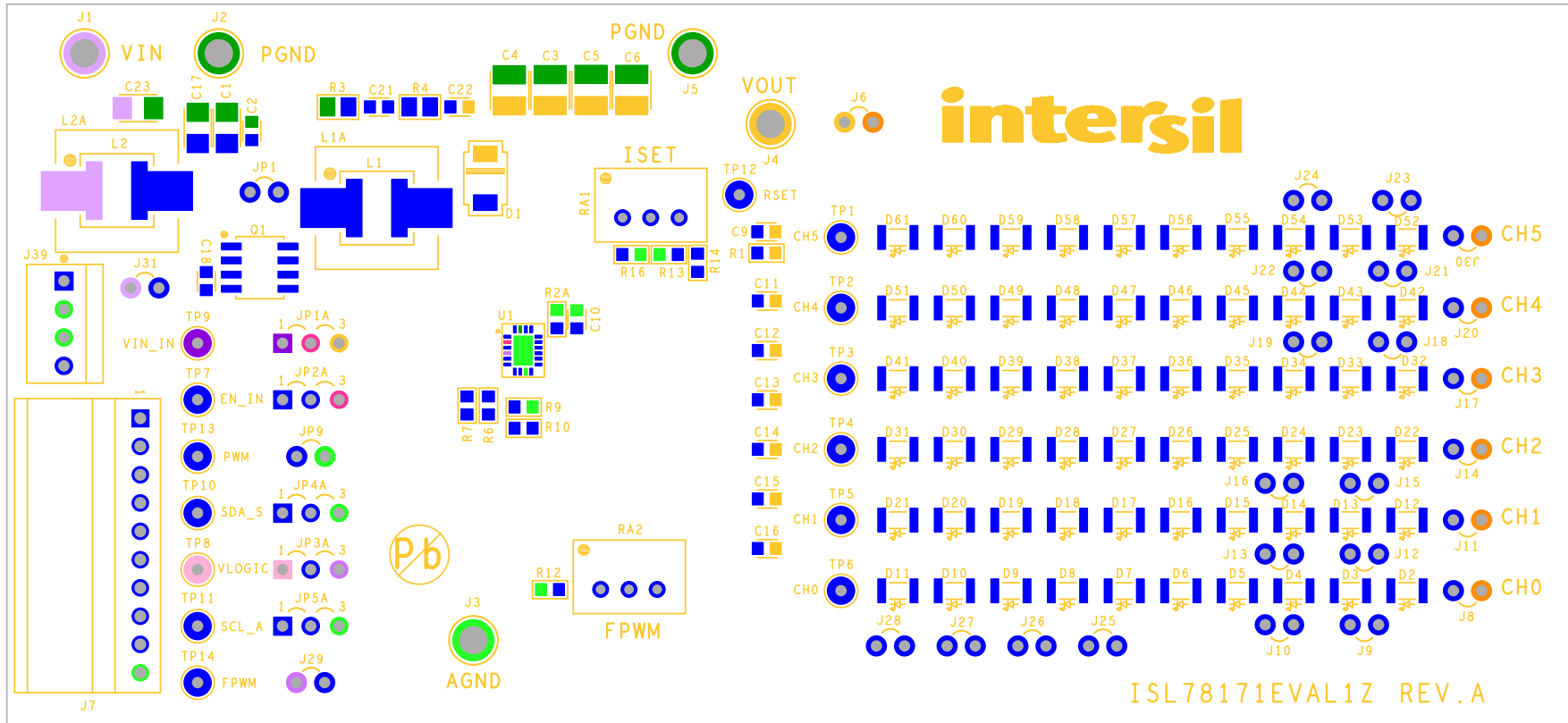

FIGURE 3. SILKSCREEN TOP

ISL78171EVAL1Z Layout (Continued)

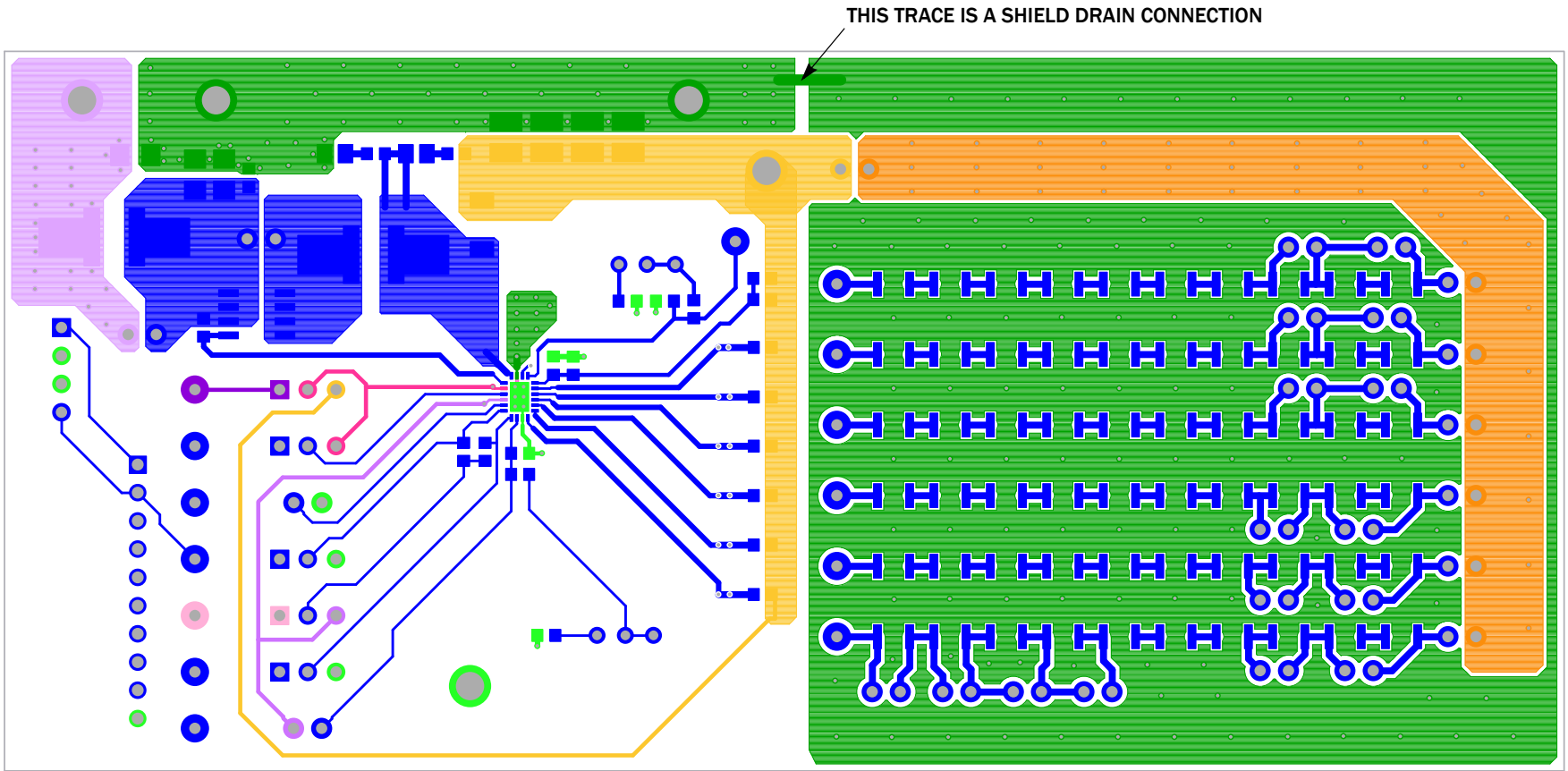

FIGURE 4. TOP LAYER

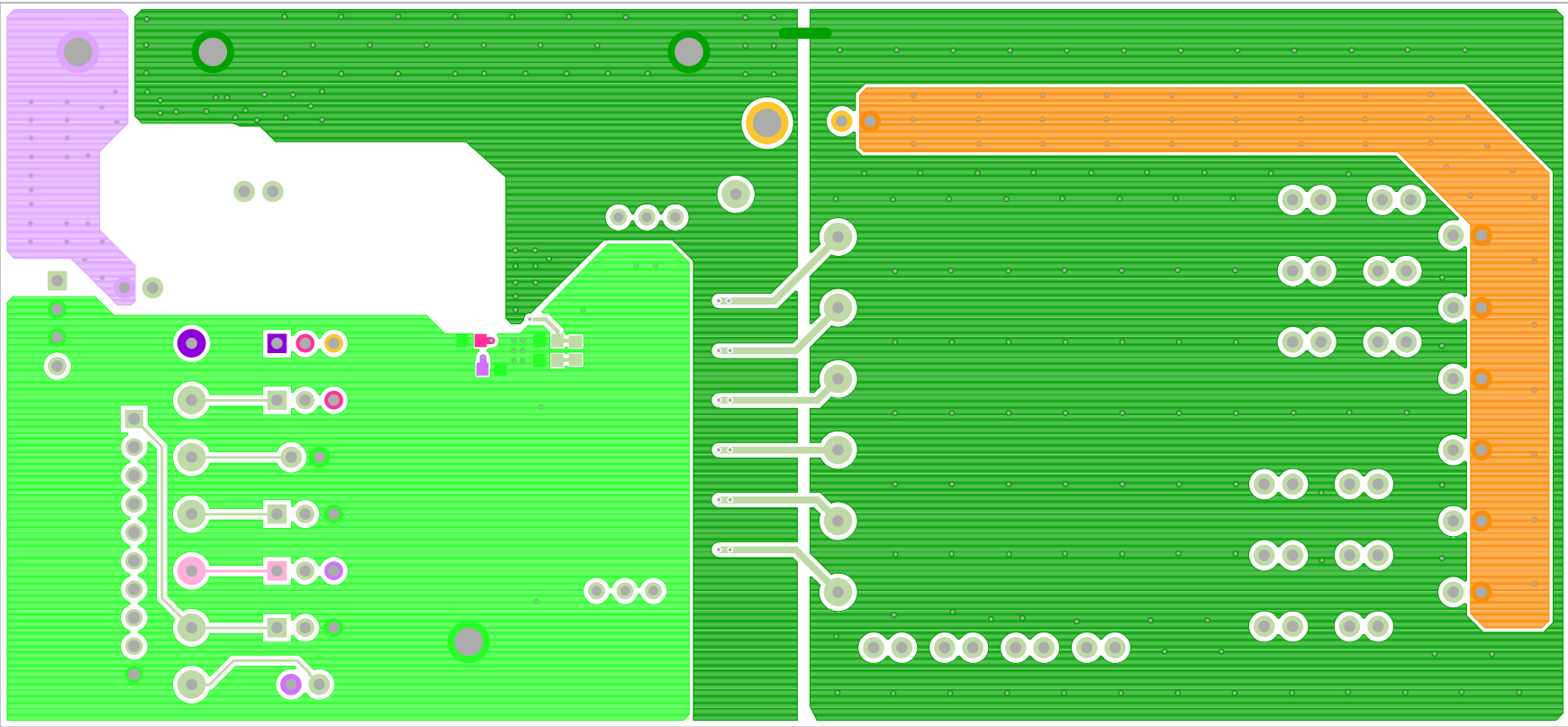

FIGURE 5. BOTTOM LAYER

ISL78171EVAL1Z Layout (Continued)

ISL78171EVAL1Z Layout (Continued)

	Direct PWM	PWM (Duty)+ FPWM (Freq.)	I2C/ SMBUS	DSPT (set<0x01>=0x01)
JP4A (SDA)	2,3	2,3	1,2	1,2
JP5A (SCL)	2,3	2,3	1,2	1,2
TP9 (PWM)	Apply	Apply	N/A	Apply
JP9 (PWM)	Open	Open	Short	Open
R10 (FPWM/FSW)	Open	0 Ohm	0 Ohm	0 Ohm
JP29 (FPWM/FSW)	Short	Open	Open	Open

Notes:
 (RA2 + R12) Can be replaced by R9
 (RA1 + R16) can be replaced by R13

Jumper/Setting	1,2	2,3
JP1A (IC Vin=)	TP9	Bootstrap
JP2A (EN=)	TP7	IC Vin
JP3A (Vlogic=)	TP8	VDC

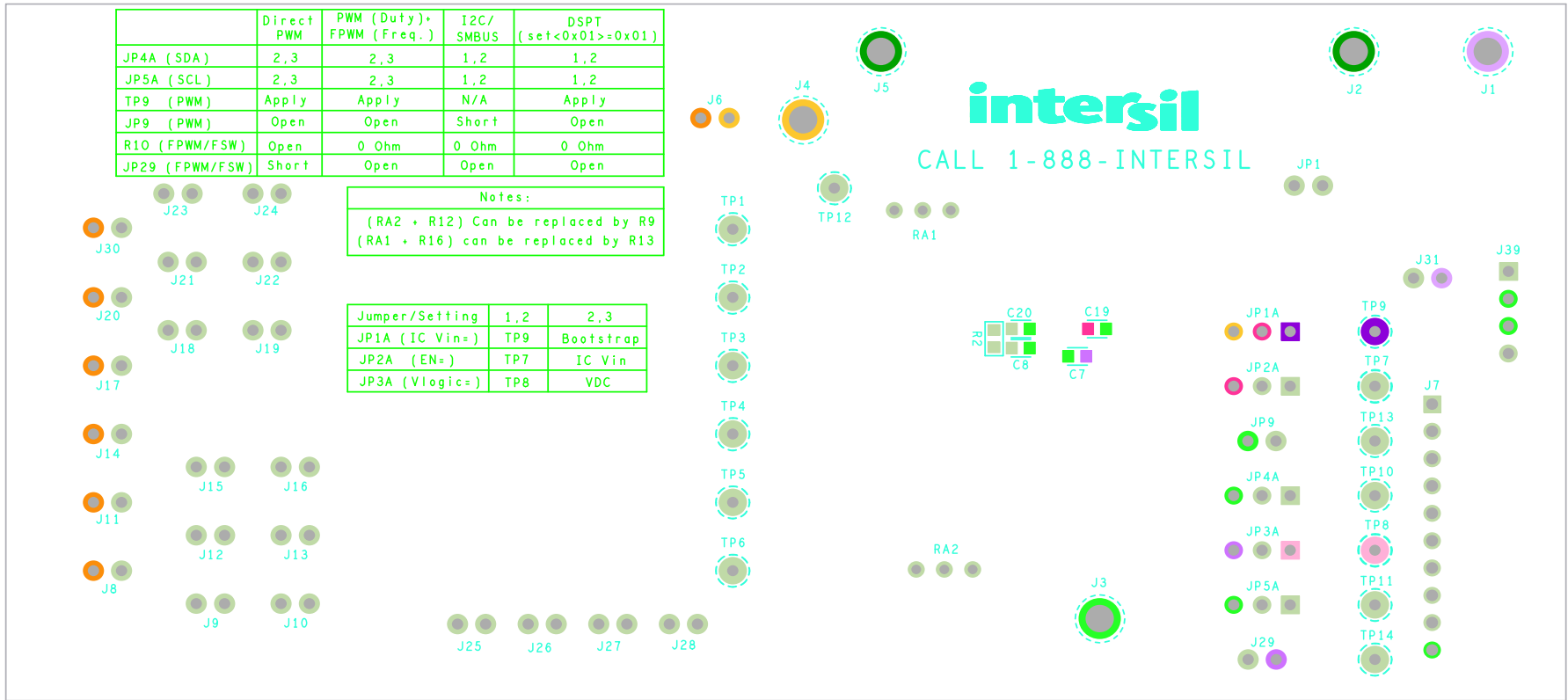

FIGURE 6. SILKSCREEN BOTTOM

ISL78171EVAL1Z Evaluation Board Schematic

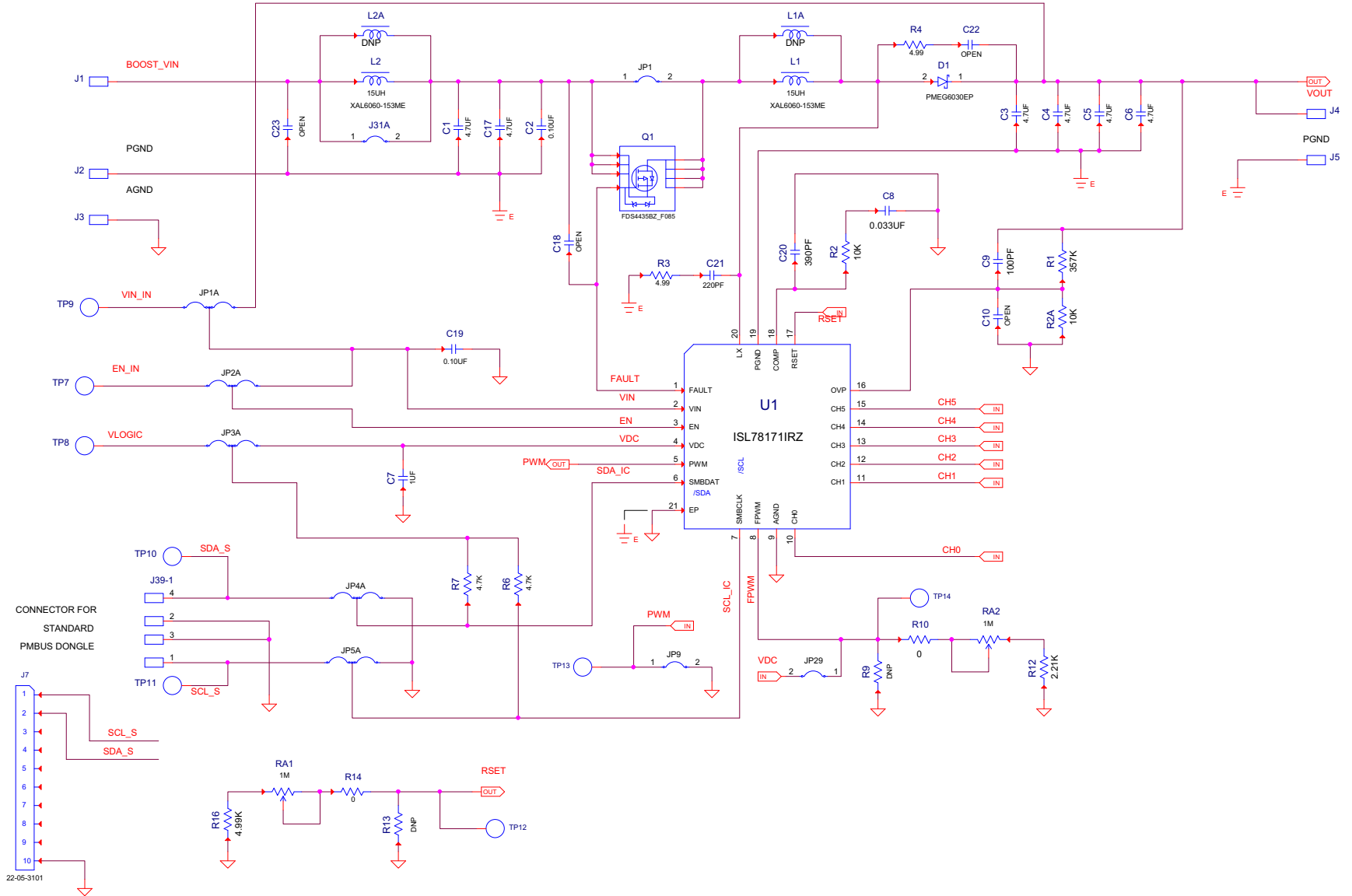

FIGURE 7. SCHEMATIC (PAGE 1)

ISL78171EVAL1Z Evaluation Board Schematic (Continued)

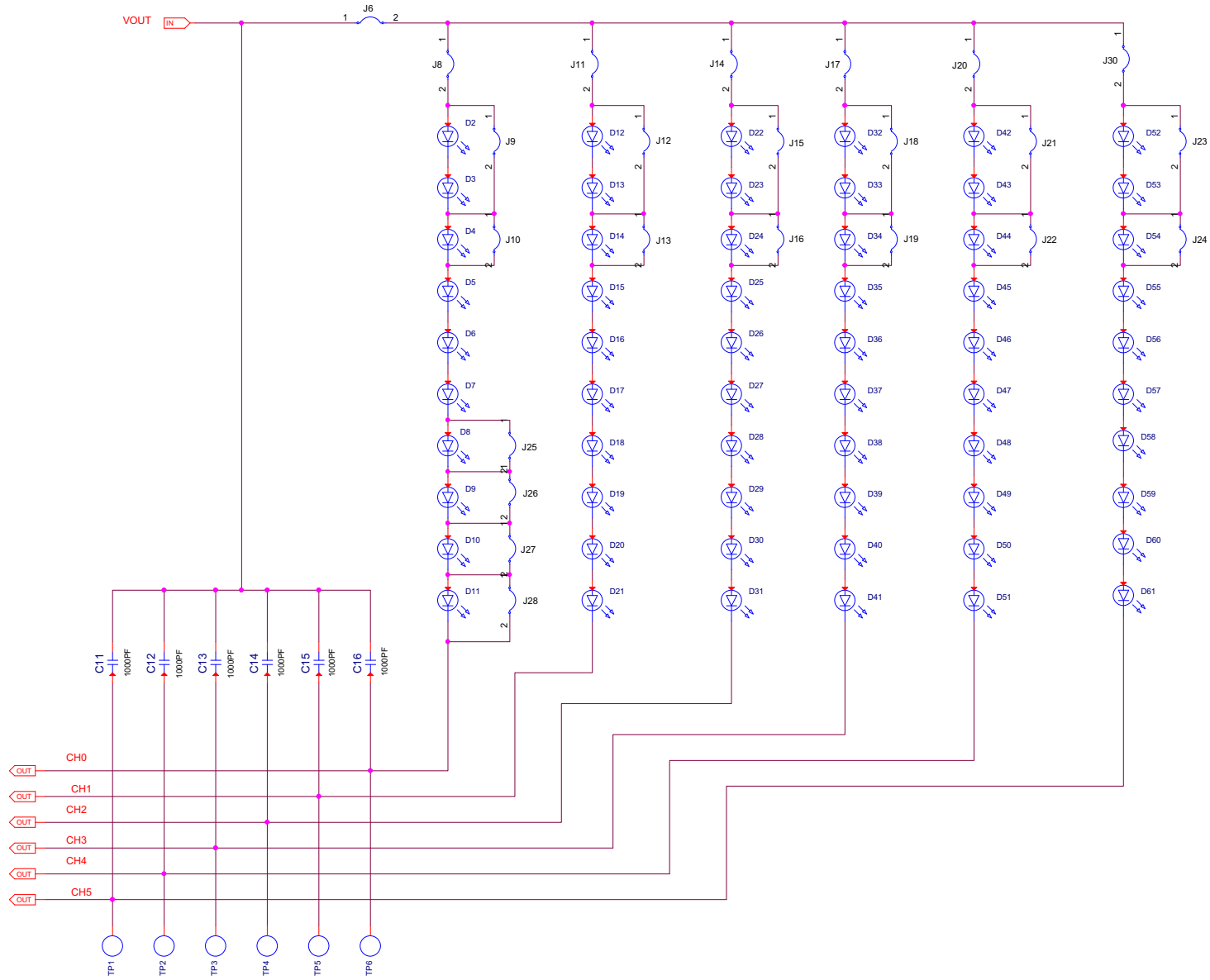

FIGURE 8. SCHEMATIC (PAGE 2)

User Guide 035

Bill of Materials

MANUFACTURER PART	QTY	UNITS	REFERENCE DESIGNATOR	DESCRIPTION	MANUFACTURER
ISL78171EVAL1ZREVAPCB	1	ea		PWB-PCB, ISL78171EVAL1Z, REVA, ROHS	IMAGINEERING INC
06031A101JAT2A	1	ea	C9	CAP, SMD, 0603, 100pF, 100V, 5%, NPO, ROHS	AVX
06033A391FAT2A	1	ea	C20	CAP, SMD, 0603, 390pF, 25V, 1%, C0G, ROHS	AVX
C0603C33K3RACAUTO	1	ea	C8	CAP-AEC-Q200, SMD, 0603, 0.033µF, 25V, 10%, X7R, ROHS	KEMET
CGA3E2X7R1H104K080AA	2	ea	C2, C19	CAP-AEC-Q200, SMD, 0603, 0.1µF, 50V, 10%, X7R, ROHS	TDK
CGA5L3X7R1H475K160AE	2	ea	C1, C17	CAP-AEC-Q200, SMD, 1206, 4.7µF, 50V, 10%, X7R, ROHS	TDK
CGA6M3X7S2A475K200AE	4	ea	C3-C6	CAP-AEC-Q200, SMD, 1210, 4.7µF, 100V, 10%, X7S, ROHS	TDK
GCJ188R72A102KA01D	6	ea	C11-C16	CAP-AEC-Q200, SMD, 0603, 0.001µF, 100V, 10%, X7R, ROHS	MURATA
ECJ-1VB2A221K	1	ea	C21	CAP, SMD, 0603, 220pF, 100V, 10%, X7R, ROHS	PANASONIC
	0	ea	C22	CAP, SMD, 0603, DNP-PLACE HOLDER, ROHS	
LMK107B7105KAHT	1	ea	C7	CAP-AEC-Q200, SMD, 0603, 1.0µF, 10V, 10%, X7R, ROHS	TAIYO YUDEN
XAL6060-153MEC	2	ea	L1, L2	COIL-PWR INDUCT, SMD, 15µH, 20%, 39.7mΩ, 11Mhz, 6.5X6.3mm, ROHS	COILCRAFT
1514-2	5	ea	J1-J5	CONN-TURRET, TERMINAL POST, TH, ROHS	KEYSTONE
22-05-3101	1	ea	J7	CONN-HEADER, TH, 10P, 2.54mm, R/A, FRICTIONLOCK, ROHS	MOLEX
22-11-2042	1	ea	J39	CONN-HEADER, 1X4, SOLID, 2.54mm, VERTICAL, FRICTION LOCK, GOLD	MOLEX
5002	14	ea	TP1-TP14	CONN-MINI TEST POINT, VERTICAL, WHITE, ROHS	KEYSTONE
68000-236HLF	5	ea	JP1A-JP5A	CONN-HEADER, 1x3, BREAKAWY 1X36, 2.54mm, ROHS	BERG/FCI
69190-202HLF	27	ea	J6, J8-J31, JP1, JP9	CONN-HEADER, 1X2, RETENTIVE, 2.54mm, 0.230X 0.120, ROHS	BERG/FCI
PMEG6030EP, 115	1	ea	D1	DIODE-SCHOTTKY RECTIFIER, SMD, SOD128, 60V, 3A, ROHS	NXP SEMICONDUCTOR
LWY87C-T1U1-3K8L-Z	60	ea	D2-D61	LED, SMD, 2P, 3X1.2, WHITE/DIFFUSED, 3.2V, 20mA, 420mcd, ROHS	OSRAM
ISL78171ARZ-T	1	ea	U1	IC-6-CHANNEL LED DRIVER, 20P, QFN, ROHS	INTERSIL
FDS4435BZ_F085	1	ea	Q1	TRANSISTOR-MOS, P-CHANNEL, 8P, SOIC, -30V, -8.8A, ROHS	FAIRCHILD
3299W-1-105LF	2	ea	RA1, RA2	POT-TRIM, TH, 1M, 0.5W, 10%, 3P, 3/8SQ, 25TURN, ROHS	BOURNS
CRCW06030000Z0EA	2	ea	R10, R14	RES, SMD, AEC-Q200, 0603, 0Ω, 1/10W, TF, ROHS	VISHAY
CRCW060310K0FKEA	2	ea	R2, R2A	RES-AEC-Q200, SMD, 0603, 10k, 1/10W, 1%, TF, ROHS	VISHAY/DALE
CRCW06032K21FKEA	1	ea	R12	RES-AEC-Q200, SMD, 0603, 2.21k, 1/10W, 1%, TF, ROHS	VISHAY/DALE

User Guide 035

Bill of Materials (Continued)

MANUFACTURER PART	QTY	UNITS	REFERENCE DESIGNATOR	DESCRIPTION	MANUFACTURER
CRCW0603357KFKEA	1	ea	R1	RES-AEC-Q200, SMD, 0603, 357k, 1/10W, 1%, TF, ROHS	VISHAY/DALE
CRCW06034K70FKEA	2	ea	R6, R7	RES-AEC-Q200, SMD, 0603, 4.7k, 1/10W, 1%, TF, ROHS	VISHAY/DALE
CRCW06034K99FKEA	1	ea	R16	RES-AEC-Q200, SMD, 0603, 4.99k, 1/10W, 1%, TF, ROHS	VISHAY/DALE
RC0805FR-074R99L	2	ea	R3, R4	RES, SMD, 0805, 4.99Ω, 1/8W, 1%, TF, ROHS	YAGEO
SJ-5003SPBL	4	ea	Bottom four corners	BUMPONS, 44inW x 20inH, DOMETOP, BLACK	3M
212403-013	1	ea	Place assy in bag	BAG, STATIC, 5X8, ZIPLOC, ROHS	INTERSIL
	0	ea	C10, C18 (0603 AUTO-AEC-Q200)	DO NOT POPULATE OR PURCHASE	
	0	ea	C23 (CGA5L3X7R1H475 K160AE)	DO NOT POPULATE OR PURCHASE	
	0	ea	L1A, L2A (SRP1038A-150M)	DO NOT POPULATE OR PURCHASE	
	0	ea	R9, R13 (0603 AUTO-AEC-Q200)	DO NOT POPULATE OR PURCHASE	

Intersil Corporation reserves the right to make changes in circuit design, software and/or specifications at any time without notice. Accordingly, the reader is cautioned to verify that the document is current before proceeding.

For information regarding Intersil Corporation and its products, see www.intersil.com

Typical Performance Curves

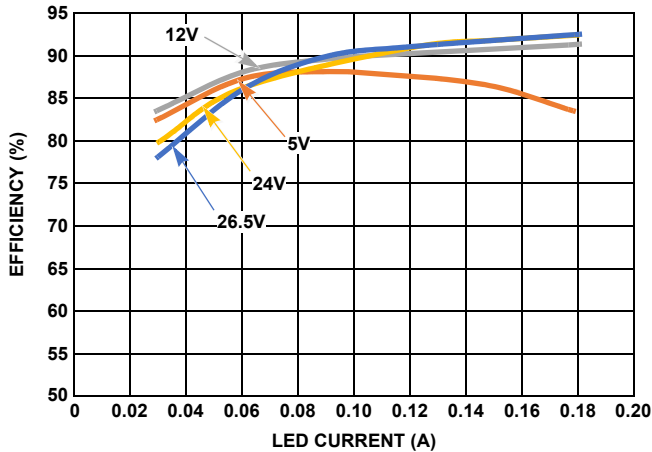

FIGURE 9. EFFICIENCY vs LED CURRENT AT LX
FREQUENCY = 600kHz AT -40°C vs V_{IN}

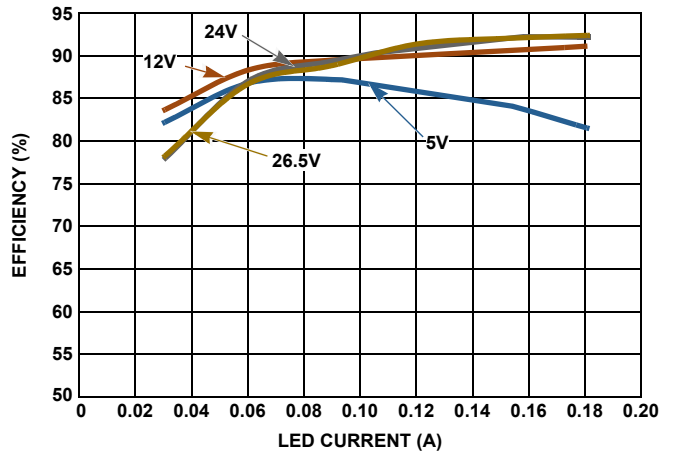

FIGURE 10. EFFICIENCY vs LED CURRENT AT LX
FREQUENCY = 600kHz AT 25°C vs V_{IN}

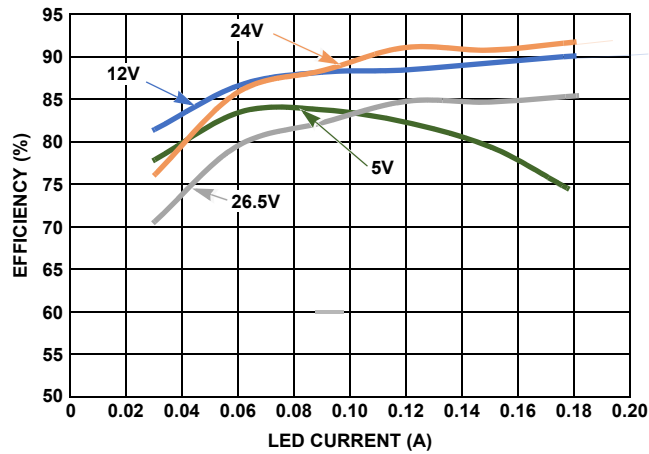

FIGURE 11. EFFICIENCY vs LED CURRENT AT LX
FREQUENCY = 600kHz AT $+105^{\circ}\text{C}$ vs V_{IN}

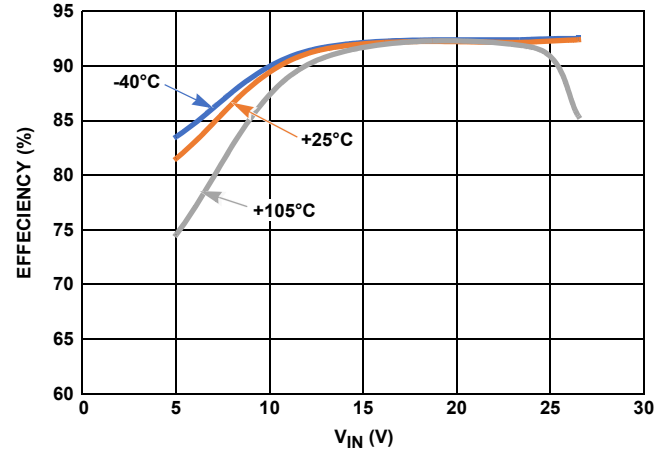

FIGURE 12. EFFICIENCY vs INPUT VOLTAGE AT LX
FREQUENCY = 600kHz vs V_{IN}

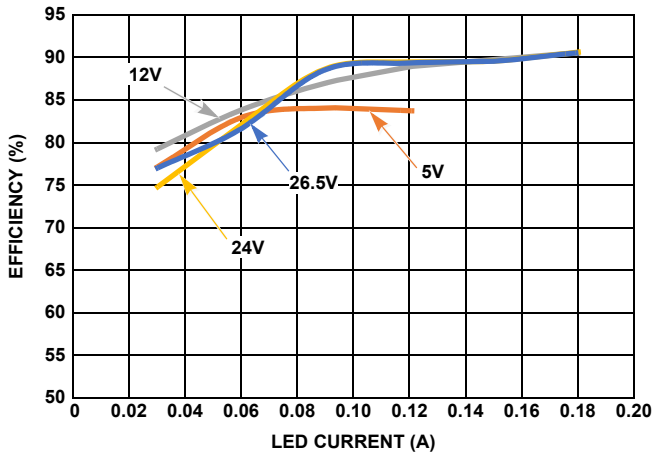

FIGURE 13. EFFICIENCY vs LED CURRENT AT LX
FREQUENCY = 1.2MHz AT -40°C vs V_{IN}

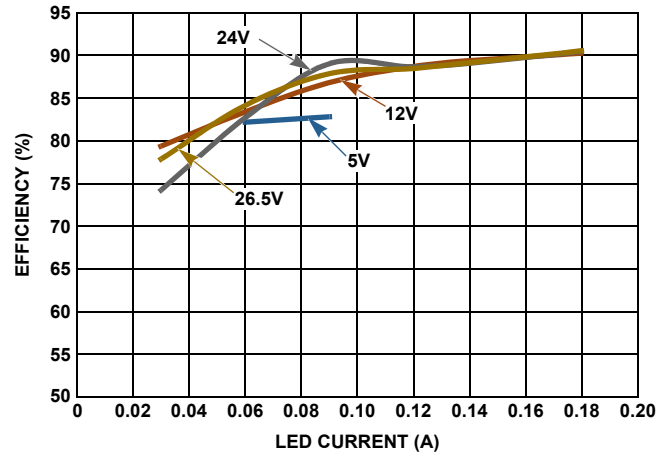

FIGURE 14. EFFICIENCY vs LED CURRENT AT LX
FREQUENCY = 1.2MHz AT 25°C vs V_{IN}

Typical Performance Curves (Continued)

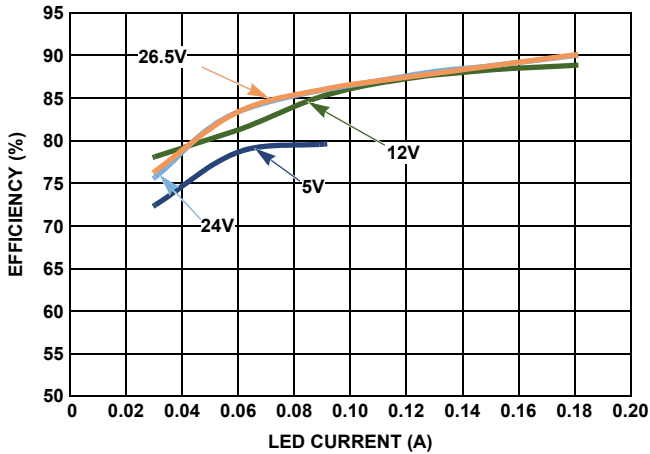

FIGURE 15. EFFICIENCY vs LED CURRENT AT LX
FREQUENCY = 1.2MHz AT +105°C vs V_{IN}

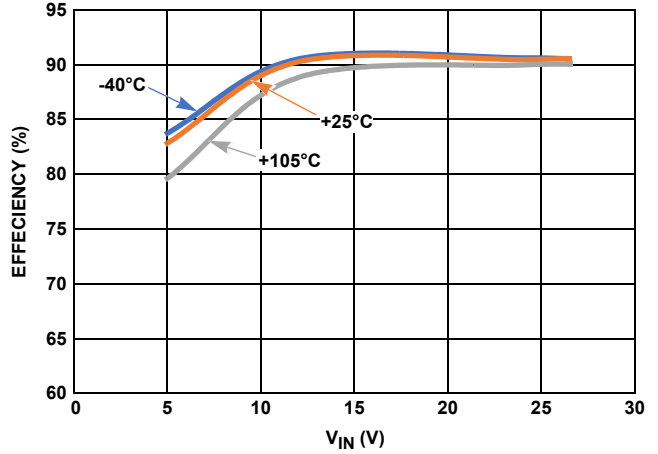

FIGURE 16. EFFICIENCY vs INPUT VOLTAGE AT LX
FREQUENCY = 1.2MHz vs V_{IN}

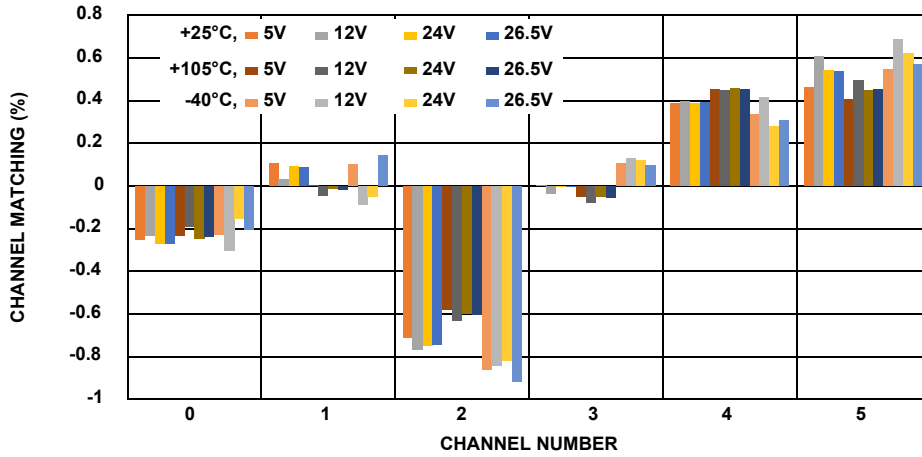

FIGURE 17. CHANNEL-TO-CHANNEL CURRENT MATCHING, 600kHz vs V_{IN}

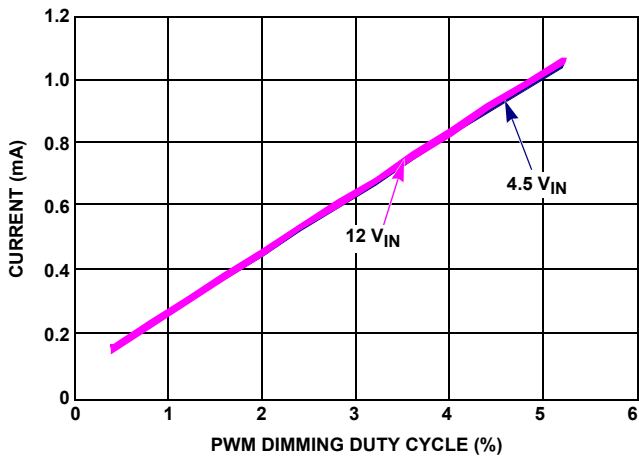

FIGURE 18. CURRENT LINEARITY vs LOW LEVEL PWM DIMMING
DUTY CYCLE vs V_{IN}

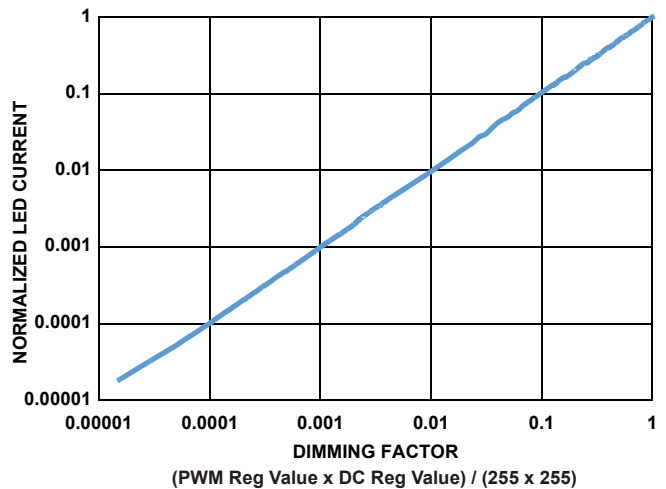

FIGURE 19. NORMALIZED LED CURRENT vs. DIMMING FACTOR,
(MEASURED AT $I_{LED} = 20mA$)